

Powder Smoke Composite Building Design As A Weapon Of Sea, Air And Land Defense Sabotage

By I Made Jiwa

Powder Smoke Composite Building Design As A Weapon Of Sea, Air And Land Defense Sabotage

I Made Jiwa Astika, Benny Sukandari, Sutrisno, Okol Sri Suharyo

Abstract: Powder smoke bombs are a type of weapon used for sabotage, phishing and disabling opponents. Sabotage is an act of destruction that is carried out in a planned, deliberate and hidden manner against equipment, personnel and activities from the target field that you want to destroy that are in the midst of the community, destruction must be displayed. The purpose of this research is to be able to make a type of sabotage weapons consisting of powder bomb smoke with the ability to deceive opponents against attacks, can also be a diversion of targets and have the ability to incapacitate and fight opponents / enemies with interests as soon as possible, as well as things that are expected to support in the field of defense research with the aim that the independence of the State in the field of defense will be realized. The method used in this study is a research method by designing a smoke bomb weapon design. This research is divided into 3 (three) preparatory stages, final stages of preparation, and other research. The output of this study is a prototype of the Powder Smoke Bomb sabotage weapon.

Keyword: Powder Smoke Bombs, Sabotage, Cysts

1. INTRODUCTION

Threats are every effort and activity, both from within and outside the country which is considered to endanger the sovereignty of the country, the territorial integrity of the country, and the safety of all nations. Military threats are threats that use armed force organized which is considered to have capabilities that endanger the sovereignty of the country, the territorial integrity of the country, and the safety of all nations. Military threats can take the form of Aggression by other countries, regional violations, espionage, sabotage, armed terrorism, armed rebellion and civil war [2]. Sabotage is a planned, intentional and hidden destruction of equipment, personnel, and activities of the intended target area that is destroyed in the midst of society, destruction must have a great psychological effect. Smoke powder bomb is a type of weapon that functions to sabotage, deceive and paralyze opponents. This weapon is designed by formulating several chemical compounds so that it can emit smoke which functions as deception and as the extermination of opponents [1]. This smoke powder firing system is by utilizing the internet network so that to trigger the smoke powder bomb can be carried out from various places and anywhere the smoke powder weapons ignition can be carried out. In connection with this matter, the researcher will compile a study, namely: Design of Composite Smoke Powder Material as a Weapon of Defense for Sea, Air and Land Defense. This research is expected to be able to contribute to sabotaging cysts and deception of opponents [3]. Based on the background, several problems can be formulated, including: (a) How to design a smoke powder bomb weapon that can function as deception and annihilation of an opponent? and (b) What is the quantity of deception of friends and the destruction of the smoke powder bomb guns?. The objectives of this study include (a) Obtain a smoke powder bomb gun design and (b) Determine the level of deception and the destruction of smoke powder weapons. Benefits of research are (a) Add to the type of military weapon, (b) Add insight into smoke powder bomb technology as a weapon of destruction with poison chemical compounds [5].

II. MATERIALS AND METHODS

II.1. Smoke Powder.

Smoke powder bomb is made from several chemical compounds such as coloring (potassium nitrate, soda (baking soda), sugar (sucrose). KNO_3 (1–3) is a salt compound composed of K^+ cations and NO_3^- anions. This compound is a strong electrolyte and is the most important nitrogen source in nature, usually, nitrate potassium is often referred to as chili saltpeter. Because it is a strong electrolyte that is easily ionized into ions, potassium nitrate has a high solubility in water, with a state of 00C in 1L of soluble nitrate water can reach 133g, but its solubility is not as large as NaNO_3 . This compound is an ionic compound composed of ion K^+ and NO_3^- (6–10) ions with white crystalline form and do not smell. Potassium Nitrate has a relative molecular mass of 101 g / mol with a density of 2.109 g / cm^3 and a melting point of 3340C. At 4000C, KNO_3 decomposes to KNO_2 (1–3). When the temperature is 00C, the solubility is 133 g/L and when the temperature is 200C the solubility is 316 g/ L. Potassium Nitrate is soluble in water, glycerol, ammonia, and is an Oxidizer or Oxidizer. Because of its Oxidizer properties, Potassium Nitrate can be used as an additive in explosives such as black powder used in World War I by American troops. Because Potassium Nitrate is an ion compound, it can be determined that its ion transport parameters such as drift speed, transport number, ion mobility, diffusion and viscosity in Fick Law I The process of purifying Potassium Nitrate was first carried out in 1270 engineer 3 Hasan al-Rammah, a chemist from Syria and written in his book entitled *al-furusiyya* was *al-Manasib al-Harbiyya* (The Book of Military Horsemanship and Ingenious War Devices). In this book, al-Rammah describes first the purification of bad (raw mineral saltpeter) through boiling it with a little water and only using a hot solution, then using potassium carbonate (in the form of wood ash) to remove calcium and magnesium through the deposition of carbonates from this solution, leaving purified potassium nitrate solution, which can then be dried. Al-Rahmmah explains the (raw mineral saltpeter) for the first time through 3 boiling with little water, using only a hot solution and using Potassium Carbonate in the form of wood ash to remove the calcium content therein and magnesium using the carbonate deposited from the solution so that it purifies and can be dried. Potassium Nitrate can be obtained from crystallized deposits in cave walls and accumulated guano bats in caves, hay, urine, nitric acid through the Harber process [4].

Potassium nitrate can be made by:

- Ammonium Nitrate and Potassium Hydroxide:

$$\text{NH}_4\text{NO}_3 (\text{aq}) + \text{KOH} (\text{aq}) \rightarrow \text{NH}_3 (\text{g}) + \text{KNO}_3 (\text{aq}) + \text{H}_2\text{O} (\text{l})$$
- Ammonium Nitrate and Potassium Chloride:

$$\text{NH}_4\text{NO}_3 (\text{aq}) + \text{KCl} (\text{aq}) \rightarrow \text{NH}_4\text{Cl} (\text{aq}) + \text{KNO}_3 (\text{aq})$$
- Nitric Acid with Potassium Hydroxide:

$$\text{KOH} (\text{aq}) + \text{HNO}_3 \rightarrow \text{KNO}_3 (\text{aq}) + \text{H}_2\text{O} (\text{l})$$
- Sodium Nitrate with Potassium Chloride:

$$\text{NaNO}_3 (\text{aq}) + \text{KCl} (\text{aq}) \rightarrow \text{NaCl} (\text{aq}) + \text{KNO}_3 (\text{aq})$$

Potassium Nitrate can be used as fertilizer, oxidizing, preserving and making food, as well as in the world of Pharmacology. In addition, Potassium Nitrate can also be used as an ingredient in anti-sensitive rockets and toothpaste. Potassium Nitrate crystals are orthorhombic at room temperature and can turn into trigonal systems at 129 ° C. On heating to temperatures between 550 and 790 ° C under atmospheric pressure, this compound releases oxygen and reaches an equilibrium with the equation: $2 \text{KNO}_3 \rightarrow 2 \text{KNO}_2 + \text{O}_2$

Potassium Nitrate can dissolve in water and will increase with increasing temperature. Its solubility in water is 133 g / L (00C) and 316 g / L (30C), but it is not soluble in alcohol and is non-toxic. Its aqueous solution is almost neutral, showing a pH of 6.2 at 14 ° C for a 10m solution of commercial powder this situation does not so hygroscopic by absorbing about 0.03m of water in 80m relative humidity over 50 days. This compound is a good oxidizer [6].

II.2. Compound Characteristics

Potassium Nitrate (KNO₃) compounds are white crystalline and odorless, easily soluble in water with a solubility of 133 g / L (00C); 316 g / L (200C). Potassium nitrate has certain physical properties that make it up. The density (ρ) of the compound is 2,109 g / cm³, the melting point is 3340C and the melting point is 607 K. This compound has a change in enthalpy (ΔH) formation with the energy of -483 kJ / mol in the liquid state and energy of -495 kJ / mol in solid-state. When viewed from the chemical properties, Potassium Nitrate is an Oxidizer or Oxidizer and has an aragonite structure with a relative molecular mass of 101 g / mol. Chemically, Potassium is very similar to Sodium which is in the same group. Both of these atoms have the first ionization energy which is the same as the possibility of removing one of the outer electrons. Potassium ions function in all living cells the transfer of potassium ions occurs through nerve cell membranes needed for normal nerve transmission [8]. Many important compounds in the industrial world contain atom nitrogen in it. For example, ammonia, nitric acid, organ nitrate, and cyanide. Nitrogen gas has a very strong triple bond with the strongest bond is a diatomic bond. Because of these properties, nitrogen is difficult to be synthesized into other compounds. Sources of Potassium Nitrate Potassium nitrate can be obtained from oxidized black powder components or commonly referred to as supplied oxygen, this salt can be produced by the Harber process. Potassium Nitrate can be obtained from deposits of crystallized cave walls, the flow of decomposed organic matter, and impurities containing ammonia and

then decomposes it into urea and other nitrogenous substances through bacterial oxidation to produce a nitrate [9]. Potassium Nitrate Synthesis Because Sodium Chloride's solubility in water is very large, the precipitated yield of this compound can be easily cleaned. The formed product can be dissolved into the water after the crystallization process, then filtered to obtain pure Potassium Nitrate. Potassium nitrate can be made by Ammonium Nitrate dan Kalium Hidroksida: Sodium Chloride the solubility in water is very large, so the result of the deposit of this compound can be cleaned easily. The product formed can be dissolved into the water after the crystallization process, then filtered to obtain pure Potassium Nitrate. Potassium nitrate can be made by:

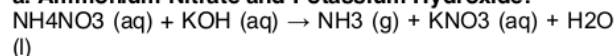
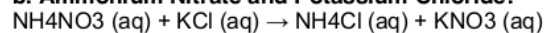
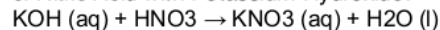
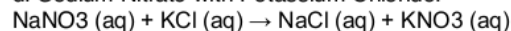
a. Ammonium Nitrate and Potassium Hydroxide:**b. Ammonium Nitrate and Potassium Chloride:****c. Nitric Acid with Potassium Hydroxide:****d. Sodium Nitrate with Potassium Chloride.**

Uses of Potassium Nitrate the addition of concentrated sulfuric acid with an aqueous solution of potassium nitrate through fractional distillation is the most useful application of potassium nitrate in the production of belching acid. In addition, potassium nitrate is also used as fertilizer, rocket fuel, some firecrackers, plays a role in making gunpowder, and sensitive toothpaste. Potassium nitrate is also useful in the cooling process, some of which are for making ice cream, also as a general composition of marinated meat [7].

II.3. Pure Baking Soda

Pure Sodium Bicarbonate (SoBi), without anti-defective substances or other substances. Supporting the pH of body cells (including in the blood) to always be in alkaline / natural conditions / pH around 7.5 Supplying O₂ and CO₂ to transport nutrients into cells & carrying residues/toxins out of cells so that they are reliable for rapid detoxification but secure. Antiseptic, anti-fungal, anti-bacterial properties that are safely applied to inflamed skin (pimples, smallpox, insect bites, eczema) or injured due to various reasons that speed up recovery. Antacids, by supplying Na minerals so that the body can produce stomach acid (HCl) in sufficient quantities to carry out the digestive process, provided that patients with gastric disorders do not limit their intake of salt in their food.

Benefits of Baking Soda:

- Body Health: As a therapy for alkaline body fluids (blood, saliva, and cell electrolyte fluids), balancing Sodium mineral levels in the body (which is the main cause of GERD)
- Skin, Hair and Dental Health.

As an antiseptic, anti-fungal, anti-bacterial which is safely applied to inflamed skin (pimples, smallpox, insect bites, eczema) or injured due to various causes that accelerate recovery. Makes skin soft, restores skin & teeth color as

before, removes black spots on the skin, pimples, stretch marks, cellulite & scars. Eliminates pain in the teeth, removes dental plaque. Stop hair loss, dandruff, hair become healthy & soft.

- Clean the surface of various materials (metal, plastic, glass, leather, vinyl, wood, and bone) from rust, scale, moss & bacterial deposits
- Clean the floor surface
- Wash the dishes.
- Washing clothes. Use a handful of salt + 1 sdm BS.
- As an Air purifier
- As a water purifier
- Get rid of insects
- For Agriculture
- For Fisheries

II.4. Coloring Chemicals

Red smoke, Strontium salt or lithium salt. Examples are lithium carbonate Li_2CO_3 which gives red color and Strontium carbonate which gives a bright red color. Orange smoke color from chemical compounds Calcium salt, for example, calcium chloride CaCl_2 , yellow smoke from chemical compounds Sodium salt, for example, sodium chloride NaCl . Green smoke from barium salt compounds or compounds that can produce Cl_2 gas. An example of barium salt is BaCl_2 . Blue smoke Copper compounds such as copper (I) chloride CuCl . Purple smoke from chemical compounds mixed between strontium salt and copper salt. Because strontium gives red and copper gives blue the mixture of the two salts will produce a purple color. White / Silver color smoke from chemical compounds Metals magnesium, titanium, or aluminum.

White smoke

Potassium nitrate - 4 parts

Charcoal - 5 parts

Sulfur - 10 parts

Wood dust - 3 parts

Red Smoke Recipe

Potassium chlorate - 15m

Red para-nitroaniline - 65m

Lactose - 20m

Green Smoke Recipe

Synthetic indigo - 26m

Auramine (yellow) - 15m

Potassium chlorate - 35m

Lactose - 26m

The formulation for colored smoke bombs comes from Wouter's Practical fireworks, which cites the recipe as coming from LP Edel, Menden en Roerenl, 2nd edition (1936).

II.5. White Smoke Bomb with Colored Flames

It's quite easy to make a colored flame by adding these **chemicals to your smoke bomb recipe:**

Chemistry Used for Red Flames - strontium salt, most easily found on flare paths Orange - calcium chloride (laundry bleaching agent) Yellow - sodium nitrate (common in chemical laboratories) Green - barium salt, like barium nitrate (common in chemical laboratories) Greenness Blue - copper sulfate (common in chemical laboratories, also found in many algicides for swimming pool treatment) Blue - copper chloride (common in chemical laboratories) Purple -

potassium permanganate (common in chemical laboratories, also used in sewage or water treatment) White - magnesium sulfate (Epsom salt, found in the washing hall or at the pharmacy)

II.6. Safety, Occupational Health, and the Environment in Blasting

Work Safety is an effort to reduce and avoid work accidents or ways to carry out work that avoids accidents. Providing a work environment or a safe environment so that work results that are profitable and free from all hazards are achieved, both for humans, machine tools, and materials or working methods when conducting mining operations. The purpose of occupational safety is to make the prevention of employees in carrying out work not getting an accident and also no damage to the tools used. Explosives are mixtures of chemical compounds that can react with high speed. The gas and heat generated from this reaction can also cause very high pressure. Explosives are an effective means of breaking down rocks in the mining industry. The explosives commonly used in the destruction of coal tanks are ANFO ammonium Nitrate-Fuel Oil ANFO ammonium Nitrate-Fuel Oil is an explosive which is classified as having a very high propagation speed reaction with high Explosive. So that the hard rock blasting operation requires special handling of the explosives, including things that need to be considered, namely storage of explosives, transportation of explosives, and blasting operation. Keywords: Explosives, Detonators [8]. Work Accidents Unexpected events (there is no element of intent) and are not expected because they cause loss, both material, and suffering for those who experience it. Sabotage or crime is an act outside the realm of an actual accident [10]. The environment is everything that exists around humans that influences the development of human life both directly and indirectly. The environment can be divided into biotic and abiotic environments. If you are in school, the biotic environment is in the form of schoolmates, teacher's mother and employees, and all the people in the school, as well as various types of plants in the school garden and the animals around them. The abiotic environment is in the form of air, table chairs, blackboards, school buildings, and various kinds of inanimate objects around. The mining industry in many cases has a dominant position in the socio-economic development of developed and developing countries. This industrial sector has a very significant impact on the positive and negative sense. Without denying the positive impact, negative impacts in the social, environmental sphere. Mining activities if carried out in forest areas can damage the forest ecosystem. If not managed properly, mining can cause overall environmental damage in the form of water, soil, and air pollution. Environmental pollution is a condition that occurs because of changes in environmental conditions (land, air and water) that are not beneficial (damaging and detrimental to the lives of humans, animals and plants) caused by the presence of foreign objects (such as garbage, industrial waste, oil, dangerous metals, etc.) as a result of human actions, resulting in the environment not functioning as before [10].

II.7. Research Methodology

Research Concept Framework

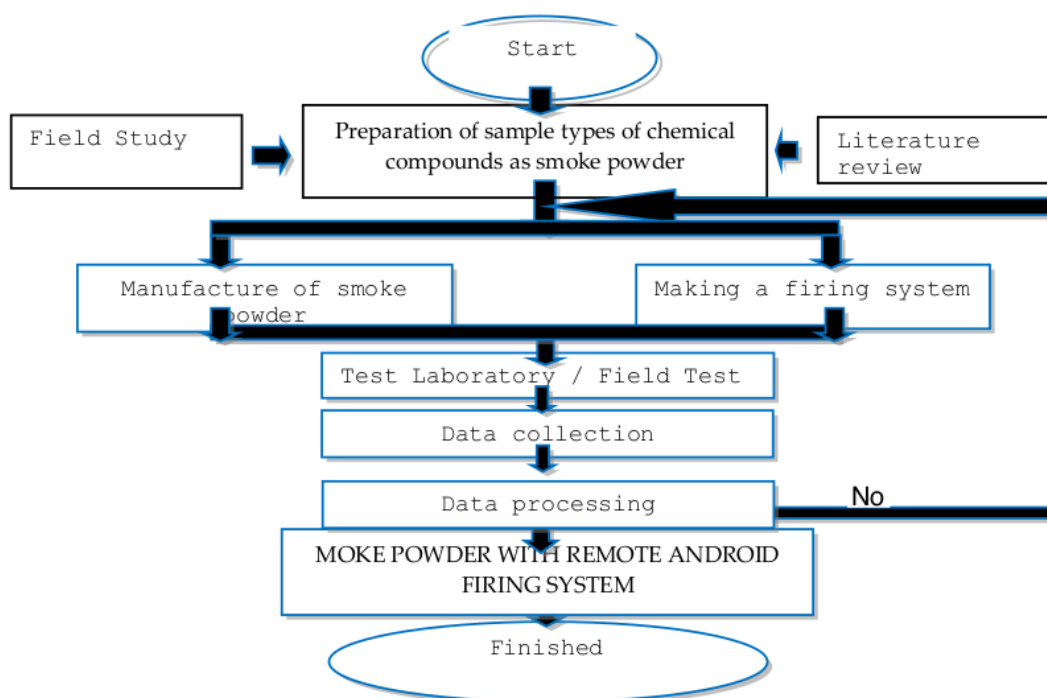

Figure 1. The Conceptual Framework

III. RESULT AND DISCUSSION

Design and Composite Smoke Powder as a Marine, Air and Ground Defense Sabotage Weapon.

III.1. Making Smoke Powder.

Smoke bombs are a type of firework designed to produce smoke when burned. The first smoke bomb was made in 1848, its inventor, Robert Yale. He developed Chinese model fireworks in the 17th century and later with a new formula, more smoke is generated with a longer time. Smoke bombs currently have several types with different specifications and materials according to their functions. For military, shows, and toys, sugar (sucrose), Potassium nitrate, KNO₃ (you can know it by the name of sendawa, sold butterfly stamp salts used in kitchen spices to soften meat), Teflon or frying pan, aluminum foil, matches (additional). The instructions to make a smoke bomb Time required: about 30 minutes,

Procedure:

a. Make a mixture of KNO₃: sugar with a composition of 5: 3 and place it on Teflon. The composition does not have to be accurate 100m, 1: 1 composition can also be used but the smoke bomb will be more difficult to

burn and burn slowly, whereas if the mixture ratio is 5: 3, the smoke bomb will burn quickly. Cook the mixture with Teflon using low heat, stir. If you see that sugar melts too quickly before you stir it. Turn off the heat and cool it again,

b. The principle is the same as making the caramel. Continue stirring and heating the mixture until it becomes a brown liquid

c. Place the liquid in aluminum foil. You can put it in small pieces in a lot of foil. Wrap with foil according to the shape you want.

d. After cooking smoke bombs. If you want to wash Teflon, do it immediately clean or you will see a smoke bomb on your Teflon. But if you don't want to be in a hurry, you can give hot water to the Teflon so that the liquid remains dissolved.

e. Cool the smoke bomb, after it cools. You can open the aluminum foil. And it's ready to ignite 7. The smoke you produce from this type of smoke bomb important: 1. if you want to make a wick, you can use a wooden stick, stick a lighter with an outside wick before wrapping it in foil.

f. If you don't want to use an axis. Try to use a long lighter to be safer.

g. When trying smoke bombs, do it in a place with a lot of ventilation or outdoors and in a place that is Non-flammable 4. Read the Material Safety Data Sheet (MSDS) before starting the procedure. How the smoke bomb works. The smoke bomb has the working principle of a reaction that produces gas and exotherm. As we know from ingredients consisting of sugar and KNO₃ as the main reagents. So this is what happens 1. KNO₃ and Sugar are mixed and heated to make the two reagents homogeneous and mixed, then the ideal reaction that occurs is $9.6\text{KNO}_3 + \text{C}_{12}\text{H}_{22}\text{O}_{11} \rightarrow 4.8\text{K}_2\text{CO}_3 + 7.2\text{CO}_2 + 11\text{H}_2\text{O} + 4.8\text{N}_2$. 3. Usually, there will be a side reaction in the form of KNO₂ and NO_x, but the main reaction is in number 2 above

Make other colored smoke bombs:

White smoke

Potassium Nitrate - 4 Parts, Charcoal - 5 Parts. Sulfur - 10 parts, wood powder - 3 parts

Red Smoke Recipe

Lithium carbonate Li_2CO_3 / Strontium carbonate - 15m red para-nitroaniline - 65m Lactose - 20m



Figure 2. Blue Smoke Recipe

Blue Smoke Recipe

Indigo synthetic - 25m, Auramine (yellow) - 15m, copper (I) CuCl chloride. Lactose - 25m



Figure 3. Yellow Smoke Recipe

Yellow Smoke Recipe

Synthetic Indigo - 25m Auramine (yellow) - 15m Potassium Chlorate - 35m Lactose - 25m

III.2. Processing and analysis of data:

The data is processed with statistical box design experimental analysis, as follows:

Table 1. Data processing with the Design Analysis Experiment.

StdOrder	Run Order	PtType	Blocks	KNO_3	Glukosa	Natrium Bicarbonate	Speed Combustion	Thickness Smoke	Sensitivity
1	1	2	1	40	20	15	38.7	971	1.9
2	2	2	1	50	20	15	34.99	984	2.15
3	3	2	1	40	30	15	35.12	983	2.14
4	4	2	1	50	30	15	31.82	995	2.27
5	5	2	1	40	25	10	36.89	975	1.99
6	6	2	1	50	25	10	32.31	990	2.22
7	7	2	1	40	25	20	33.54	988	2.16
8	8	2	1	50	25	20	34.59	980	2.07
9	9	2	1	45	20	10	38.98	972	1.92
10	10	2	1	45	30	10	35.57	990	2.22
11	11	2	1	45	20	20	36.61	994	2.18
12	12	2	1	45	30	20	37.55	957	1.98
13	13	0	1	45	25	15	39.95	961	1.63
14	14	0	1	45	25	15	31.97	996	2.25
15	15	0	1	45	25	15	36.1	982	2.06

Response Surface Regression: Sensitivity versus KNO_3 , Glukosa, Natrium Bikarbonat. The analysis was done using coded units. Estimated Regression Coefficients for Sensitivity

Term	Coef	SE Coef	T	P
Constant	1.98000	2.565	0.772	0.475
KNO_3	0.06500	1.571	0.041	0.969

Glukosa	2.55500	1.571	1.626
0.165			
Natrium Bikarbonat	-2.49250	1.571	-1.587
0.173			
KNO3*KNO3	-2.41250	2.312	-1.043
0.345			
Glukosa*Glukosa	2.54750	2.312	1.102
0.321			
Natrium Bikarbonat*	2.54250	2.312	1.099
0.322			
Natrium Bikarbonat			
KNO3*Glukosa	-0.03000	2.222	-0.014
0.990			
KNO3*Natrium Bikarbonat	-0.08000	2.222	-
0.036	0.973		
Glukosa*Natrium Bikarbonat	-5.12000	2.222	-
2.305	0.069		

S = 4.44340 P² SS = 1576.73
 R-Sq = 73.94% R-Sq(pred) = 0.00% R-Sq(adj) = 27.02%

Analysis of Variance for Sensitifitas

Source	DF	Seq SS	Adj SS	Adj MS	F	P
Regression	9	280.030	280.030	31.1145		
1.58	0.321					
Linear	3	101.958	101.958	33.9862	1.72	0.278
Square	3	73.185	73.185	24.3950	1.24	0.389
Interaction	3	104.887	104.887	34.9623	1.77	0.269
Residual Error	5	98.719	98.719	19.7438		
Lack-of-Fit	3	98.517	98.517	32.8390	325.46	0.203
Pure Error	2	0.202	0.202	0.1009		
Total	14	378.749				

Obs	StdOrder	Sensitifitas	Fit	SE Fit	Residual	St Resid
1	1	1.900	-0.535	3.848	2.435	
1.10						
2	2	2.150	-0.345	3.848	2.495	
1.12						
3	3	2.140	4.635	3.848	-2.495	-
1.12						
4	4	2.270	4.705	3.848	-2.435	-
1.10						
5	5	1.990	4.458	3.848	-2.468	-
1.11						
6	6	2.220	4.748	3.848	-2.528	-
1.14						
7	7	2.160	-0.368	3.848	2.528	
1.14						
8	8	2.070	-0.398	3.848	2.468	
1.11						
9	9	1.920	1.887	3.848	0.033	
0.01						
10	10	22.200	17.237	3.848	4.963	
2.23	R					

11	11	2.180	7.142	3.848	-4.962	-
2.23	R					
12	12	1.980	2.012	3.848	-0.032	-
0.01						
13	13	1.630	1.980	2.565	-0.350	-
0.10						
14	14	2.250	1.980	2.565	0.270	
0.07						
15	15	2.060	1.980	2.565	0.080	
0.02						

8

R denotes an observation with a large standardized residual. Estimated Regression Coefficients for Sensitifitas using data in uncoded units

Term	Coef
Constant	-193.055
KNO3	8.77600
Glukosa	-1.45800
Natrium Bikarbonat	1.71450
KNO3*KNO3	-0.0965000
Glukosa*Glukosa	0.101900
Natrium Bikarbonat*	0.101700
Natrium Bikarbonat	
KNO3*Glukosa	-0.00120000
KNO3*Natrium Bikarbonat	-0.00320000
Glukosa*Natrium Bikarbonat	-0.204800

From the analysis of the data above, the mixture of KNO3, Glucose, and Natrum Bicarbonate is very significant in the sensitivity of the combustion of smoke powder by the combustion axis.



Figure 4. Response of Sensitivity

Response Surface Regression: Speed⁹ombustion versus KNO3, Glukosa, Natrium Bika The analysis was done using coded units. Estimated Regression Coefficients for Kecepatan Bakar

Term	Coef	SE Coef	T	P
Constant	36.0067	1.5430	23.335	0.000
KNO3	-1.3175	0.9449	-1.394	0.222
Glukosa	-1.1525	0.9449	-1.220	0.277
Natrium Bikarbonat	-0.1825	0.9449	-0.193	0.854

KNO ₃ *KNO ₃	-1.8471	1.3909	-1.328
0.242			
Glukosa*Glukosa	0.9979	1.3909	0.717
0.505			
Natrium Bikarbonat*	0.1729	1.3909	0.124
0.906			
Natrium Bikarbonat			
KNO ₃ *Glukosa	0.1025	1.3363	0.077
0.942			
KNO ₃ *Natrium Bikarbonat	1.4075	1.3363	
1.053	0.340		
Glukosa*Natrium Bikarbonat	1.0875	1.3363	
0.814	0.453		
S = 2.67263	P ₂ = 133.452		
R-Sq = 60.67%	R-Sq(pred) = 0.00%	R-Sq(adj) = 0.00%	

Analysis of Variance for Kecepatan Bakar

Source	DF	Seq SS	Adj SS	Adj MS	F	P
Regression	9	55.104	55.104	6.123	0.86	0.605
Linear	3	24.779	24.779	8.260	1.16	0.413
Square	3	17.628	17.628	5.876	0.82	0.535
Interaction	3	12.697	12.697	4.232	0.59	0.646
Residual Error	5	35.715	35.715	7.143		
Lack-of-Fit	3	3.861	3.861	1.287	0.08	0.964
Pure Error	2	31.853	31.853	15.927		
Total	14	90.818				

From the analysis of the data above, the mixture of KNO₃, Glucose, Natrium Bicarbonate is very significant on the speed of combustion of smoke powder by the combustion axis.

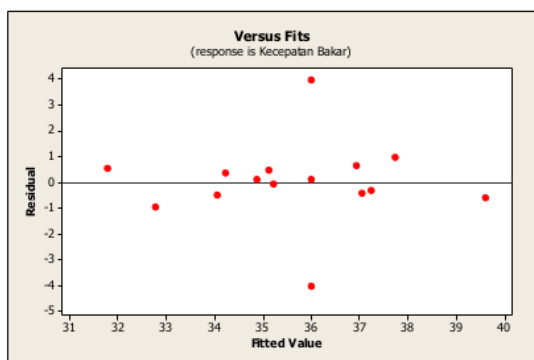

Figure 5. Speed of Combustion

Response Surface Regression: Thickness Smoke versus KNO₃, Glukosa, Natrium Bika. The analysis was done using coded units. Estimated Regression Coefficients for Ketebalan Smoke

Term	Coef	SE Coef	T	P
Constant	979.667	7.772	126.043	
KNO ₃	4.000	4.760	0.840	0.439
Glukosa	0.500	4.760	0.105	
0.920				

Natrium Bikarbonat	-1.000	4.760	-0.210
0.842			
KNO ₃ *KNO ₃	4.292	7.006	0.613
0.567			
Glukosa*Glukosa	-0.708	7.006	-0.101
0.923			
Natrium Bikarbonat*	-0.708	7.006	-0.101
0.923			
Natrium Bikarbonat			
KNO ₃ *Glukosa	-0.250	6.731	-0.037
0.972			
KNO ₃ *Natrium Bikarbonat	-5.750	6.731	
0.854	0.432		
Glukosa*Natrium Bikarbonat	-13.750	6.731	
2.043	0.097		

S = 13.4623 P₂ = 5964.5
R-Sq = 54.88% R-Sq(pred) = 0.00% R-Sq(adj) = 0.00%

Analysis of Variance for Ketebalan Smoke

Source	DF	Seq SS	Adj SS	Adj MS	F	P
Regression	9	1102.23	1102.23	122.47	0.68	0.713
Linear	3	138.00	138.00	46.00	0.25	0.856
Square	3	75.48	75.48	25.16	0.14	0.933
Interaction	3	888.75	888.75	296.25	1.63	0.294
Residual Error	5	906.17	906.17	181.23		
Lack-of-Fit	3	285.50	285.50	95.17	0.31	0.823
Pure Error	2	620.67	620.67	310.33		
Total	14	2008.40				

From the analysis of the data above, the mixture of the ratio of KNO₃, Glucose, Natrium Bicarbonate is very significant for the smoke powder thickness by the fuel axis.

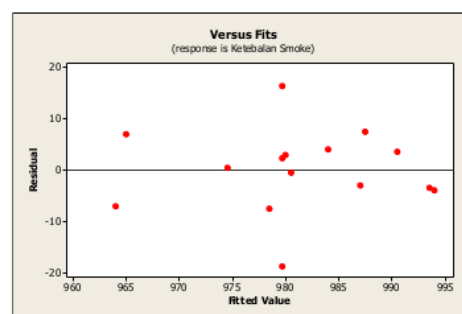

Figure 6. The thickness of Smoke.

III.3. Smoke Powder Firing System

The firing smoke powder system with the smoke ignition satellite system through Handpoon connectivity. The system works as follows: In the smoke powder tube is equipped with an electric circuit that functions as a receiver of a hand poon call, if there is a call through a handphone then the electric circuit is active / connected, then the

current is strengthened again with a dc power of 9 volts and a nickel wire connector that functions as an ignition source, nickel wire burns and can burn the smoke axis of the smoke powder then burn smoke. The firing smoke powder system scheme is as follows:

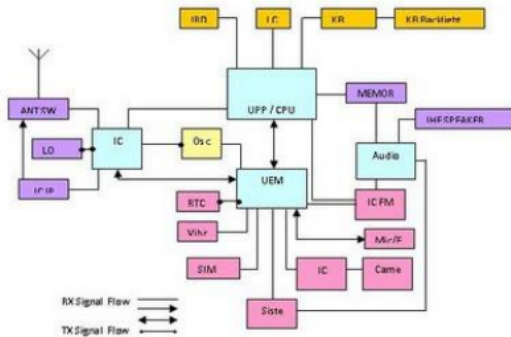

Figure 7. The Firing Smoke Powder System Scheme

The basic structure of a mobile phone consists of 2 parts, namely hardware and software. The basic structure of important units on mobile phones can be described as follows:

- Transmission unit receives
- (Transceiver)
- Power supply unit
- Logic unit
- The latest integrated unit features

1. Hardware device

Hardware is a hardware device on a mobile machine that consists of various blocks of electronic circuit functions along with their supporting components. The basic structure of hardware on mobile phones is as follows.

2. Baseband.

Baseband is the basic center of the main arrangement on mobile phones that has an electric power supply unit as a mobile power source. Baseband units basically have the following components.

a. Power is the electrical regulator in the baseband area, including the battery charging power source, user interface control, digital audio coding settings, storage of partial data security control, and mobile Start system which also plays a major role in the frequency regulator audio is hardware integration in basic components (global), namely lower, Audio, and haring (on the Nokia handphone model, these components are programmable).

b. Audio IC

Basically, this component can change, adjust, and encode digital signals encode analog signals that will be fed to the five human senses in the form of sound. This component also has the role of separating the information signal in the form of data to be processed as S01 (0-numeric signal) or traffic signal to appear on the layer.

c. IC Charging

Charging this component functions as charging the battery and controlling the digital charging of the battery.

d. CPU (Central Processing Unit) An integrated control center that functions as a user input controller for the translation process data

e. Plash memory (RAM-ROM) is in charge of deviating from operating data and for maintaining the identity of the handphone. In addition, these components have interrelated circuits to provide information on block radio frequency

3. User interface

The intermediary part of the cellphone to the human senses is called the input-output component, the speaker, vibrator, keypad, and microphone. Additional features of the latest user interface, namely video call, television, and Bluetooth cameras which are increasingly popular and have become a necessity for today's mobility.

4. Radiofrequency (Bok Transceiver)

Radiofrequency is a conduit of user identities that functions to process data information signals and carrier signals to be transmitted through an antenna. the base box of this area consists of a Tx transmitter system and a receiver that has a different frequency setting access system 4 different. on the Tx transmitter box, the results of processing user information in the baseband area in the form of data or voice information that is decoded to be united with a carrier signal and processed through the processor as an intermediary for signal processing. The power component is strengthened to be fed to the antenna. On the cloudy side is the RX receiver block, which is the direction of incoming information signals captured from the antenna, processed by the processor, and forwarded to the audio encoding to produce a signal in the form of data which will be translated by the information control unit. voice data on the speaker.

5. Cellular telephone communication systems. The concept of cellular telephone networks is similar to wired telephones but differs from intermediary media use. There is a cellular telephone system using a base station that functions as a liaison station in the process of sending and receiving messages that are still in the coverage area. Each coverage made by a base station is called a cell that is capable of reaching an area of several tens of kilometers. Communication is technology based on developed by a study group called 'Roupe Special to study and develop public telecommunications systems in Europe.

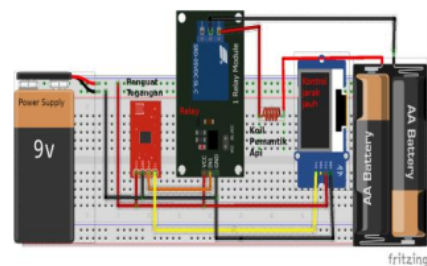

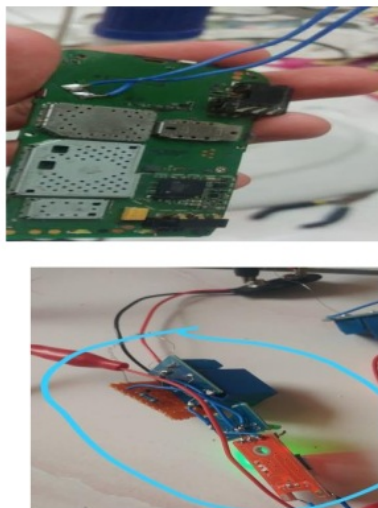

Figure 8. Firing Sistem of Smoke Powder.

IV. CONCLUSION

From the results of the above discussion it can be concluded as follows:

- a. It can be used as an alarm system for smoke powder bombs that can be used as an attack on opponents for attacks and are poisonous to paralyze it and equipped with a firing system with an Android system.
- b. It can add to the completeness of the military defense system.

V. FUTURE WORK

- a. The results of this study can be followed up by cooperating with SOEs in the field of terrorism so that they can be produced in large quantities.
- b. The results of this research can be further developed so that the level of sophistication of the technology can develop.

ACKNOWLEDGMENT.

The authors greatly acknowledge the support from Indonesian Naval Technology College STTAL Surabaya Indonesia for providing the necessary resources to carry out this research work. The authors are also grateful to the anonymous reviewers and editorial board for their many insightful comments, which have significantly improved this article.

REFERENCES

- [1] Anonymous, https://id.wikipedia.org/wiki/Efek_Munroe
- [2] Anonymous, <https://elib.unikom.ac.id/.../jbptunikompp-gdl-aamsitif-28858-6-u>
- [3] Gordon S Kino 1987 *Acoustic Wave: Devices, Imaging, and Analog Signal Processing*. Prentice-Hall.
- [4] Gordon. E. 1996, *Tactical Missile Propulsion*, Amerika Institute Aeronautics, Inc California.
- [5] Kenneth, G, W 1967, *Military Explosives*, Departemen of the Army and the Air Force,

- [6] Washington, Dc.
- [6] Le Méhauté, Bernard; Wang, Shen (1995). *Water waves generated by an underwater explosion*. World Scientific Publishing.
- [7] Meyer, R 1981, *Explosive* Verlag Chemie, Deerfield Beach, Florida- Basel.
- [8] Suharjo B, Suharyo O.S., 2019, The Naval Harbours Priority Development Using Zero-One Matrix Decision Variable (ZOMDV) and Fuzzy Mcdm Methods; A Case Study, *International Journal of Civil Engineering and Technology (IJCIET)* Volume 10, Issue 02, February 2019, 623-634.
- [9] Suharyo O.S., Djauhar Manfaat, Haryo D Armono, 2017, Establishing the Location of Naval Base Using Fuzzy MCDM and Covering Technique Methods: A Case Study, *International Journal of Operations and Quantitative Management, IJOQM*, Vol. 23, Issue 1, pp 61-87.
- [10] Jusilo A.K, Ahmadi, Suharyo O.S, Pratisna P., 2017, Applied of Impressed Current Cathodic Protection Design For Fuel Pipeline Network at Naval Base, *Iranian Journal of Materials Science and Engineering*, Vol. 14 Issue 2 pp. 41-53.

Powder Smoke Composite Building Design As A Weapon Of Sea, Air And Land Defense Sabotage

ORIGINALITY REPORT

10%

SIMILARITY INDEX

PRIMARY SOURCES

- 1** S. Uma Maheswari, S. S. Dhenakaran. "Aspect based Fuzzy Logic Sentiment Analysis on Social Media Big Data", 2020 International Conference on Communication and Signal Processing (ICCSP), 2020 136 words — 2%
Crossref
- 2** Pere Grima Cintas, Lluís Marco Almagro, Xavier Tort-Martorell Llabrés. "Part Six: Case Studies", Wiley, 2012 112 words — 2%
Crossref
- 3** Joshi, Chirag S., Manish R. Shukla, Krunal Patel, Jigar S. Joshi, and Omprakash Sahu. "Environmentally and Economically Feasibility Manufacturing Process of Potassium Nitrate for Small Scale Industries: A Review", International Letters of Chemistry Physics and Astronomy, 2014. 111 words — 2%
Crossref
- 4** "The Influence of Leadership, Professional Attitude, and Trust on the Performance of Navy Officers", International Journal of Innovative Technology and Exploring Engineering, 2019 57 words — 1%
Crossref
- 5** "The Application of CBA and SUG Model for Improving The Quality of Indonesian Navy Human Resources", International Journal of Recent Technology and Engineering, 2019 51 words — 1%
Crossref
- 6** A A Sadat, M A Basir, L M H Adan, A Nazar, M Ulfa, M R Rukka, M Arsyad. "Impact of Lambusango Forest Damage on Environment", IOP Conference Series: Earth and 42 words — 1%

-
- 7 Susilo Kukuh, Udisubakti Ciptomulyono, Nengah Putra, A Ahmadi, Okol Suharyo. "Navy ability development strategy using SWOT analysis-interpretative structural modeling (ISM)", Strategic Management, 2019
20 words — < 1%
Crossref
-
- 8 Christoph Karrer. "Chapter 8 Appendix", Springer Science and Business Media LLC, 2011
20 words — < 1%
Crossref
-
- 9 Badiru, . "Design of experiment techniques", Industrial Innovation, 2011.
19 words — < 1%
Crossref
-
- 10 "Performance Evaluation of High-Strength High-Volume Fly Ash Concrete", International Journal of Recent Technology and Engineering, 2019
15 words — < 1%
Crossref
-
- 11 Sourabh Koli, P. Chellapandi, Lokavarapu Bhaskara Rao, Akshay Sawant. "Study on JWL equation of state for the numerical simulation of near-field and far-field effects in underwater explosion scenario", Engineering Science and Technology, an International Journal, 2020
14 words — < 1%
Crossref
-
- 12 A. M. A. Al-Ahmari. "Prediction and optimisation models for turning operations", International Journal of Production Research, 2008
11 words — < 1%
Crossref
-
- 13 Vashishth, A.K.. "Waves in stratified anisotropic poroelastic media: a transfer matrix approach", Journal of Sound and Vibration, 20041006
10 words — < 1%
Crossref
-
- 14 Carol E. Aziz, Paul B. Hatzinger. "Chapter 4 Perchlorate Sources, Source Identification And Analytical Methods", Springer Science and Business Media LLC, 2008
8 words — < 1%

Crossref

EXCLUDE QUOTES OFF
EXCLUDE
BIBLIOGRAPHY OFF

EXCLUDE MATCHES OFF